

コイン形二酸化マンガンリチウム電池  
Coin manganese dioxide lithium batterie

# CR2050W

■外形寸法 Dimensions(mm)

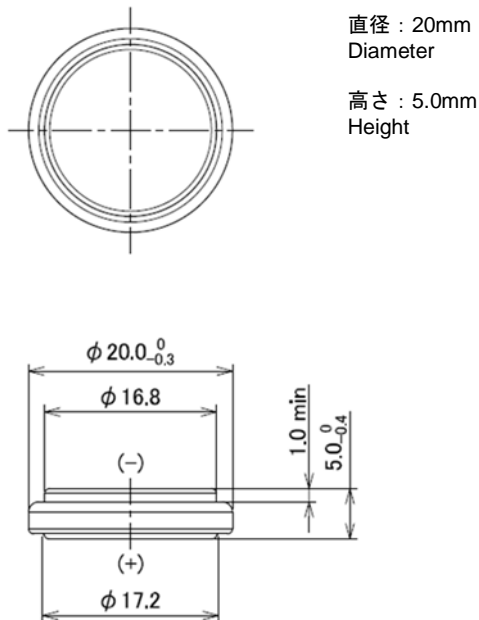

(Unit : mm)

■定格 Specifications

公称電圧 <b>Nominal Voltage</b>	3 V
公称容量 (終止電圧 2.0V) <b>Nominal Capacity (2.0V cutoff)</b>	345 mAh
推奨連続放電電流値 (容量利用率高) <b>Recommended Continuous Discharge Current (High capacity usage rate)</b>	≤ 1 mA
標準質量 <b>Weight</b>	4.2 g
使用温度範囲 <b>Operating Temperature</b>	-40 ~ +125°C

用途 Applications

- TPMS(タイヤ空気圧監視システム)
  - ETC
  - FA機器
  - SRAMやリアルタイムクロック等メモリーバックアップ
  - その他高温/低温環境で使われる機器
- TPMS (Tire Pressure Monitoring System)
  - ETC (Electronic Toll Collection System)
  - Factory Automation Instruments
  - Memory Back-up Power Source for SRAM and Real Time Clock (RTC)
  - Other devices used in wide temperature environment

UL認定合格部品 UL Recognized components

- 許可番号 Certification number : MH12566
- Technician replaceable

■放電特性

Discharge Characteristics

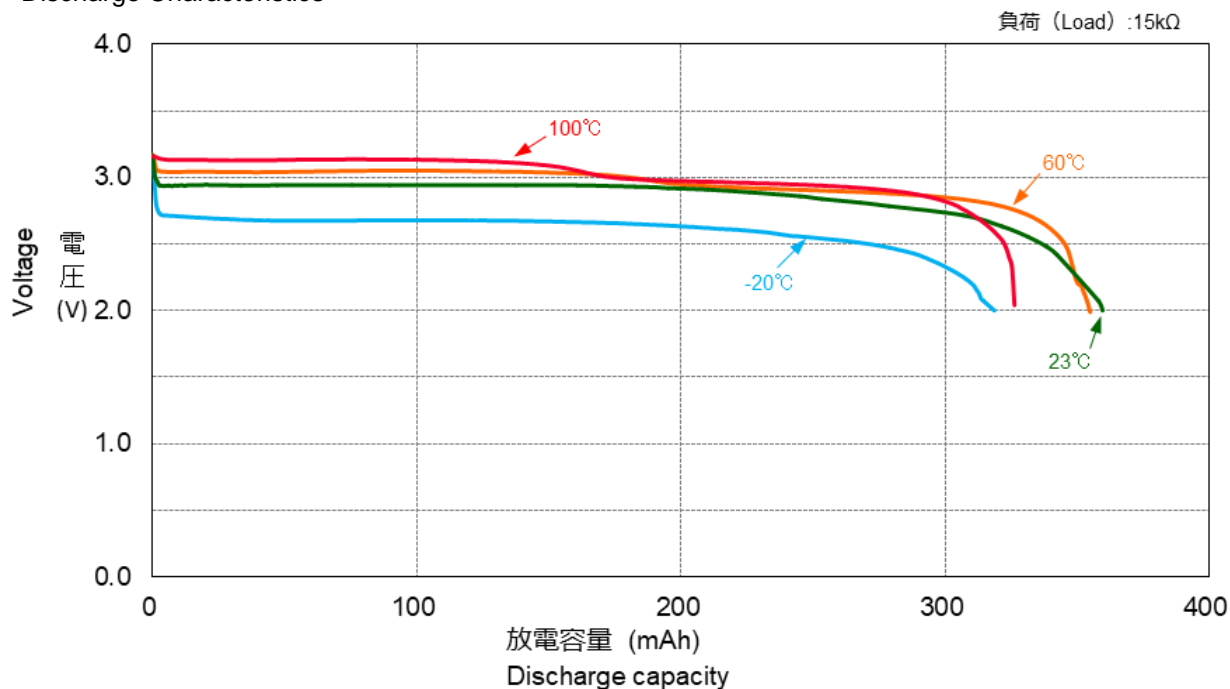

■ 放電負荷特性

Discharge Characteristics by Load

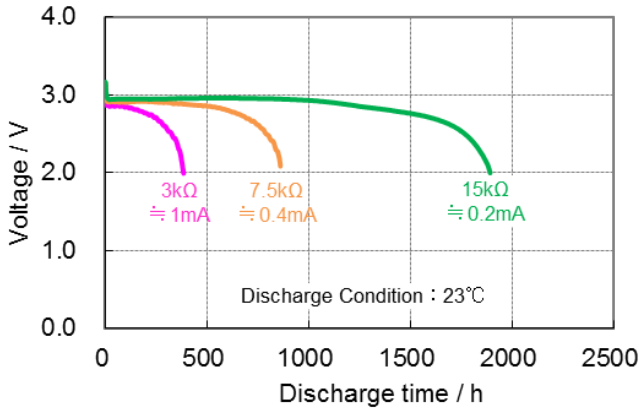

■ 放電温度特性

Discharge Characteristics by Temperature

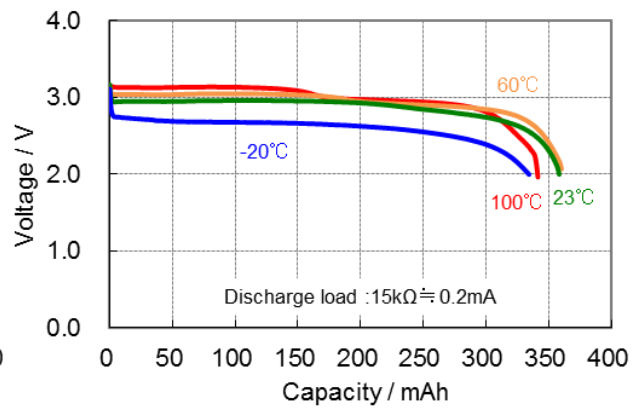

■ 閉路電圧特性

Closed Circuit Voltage by Temperature

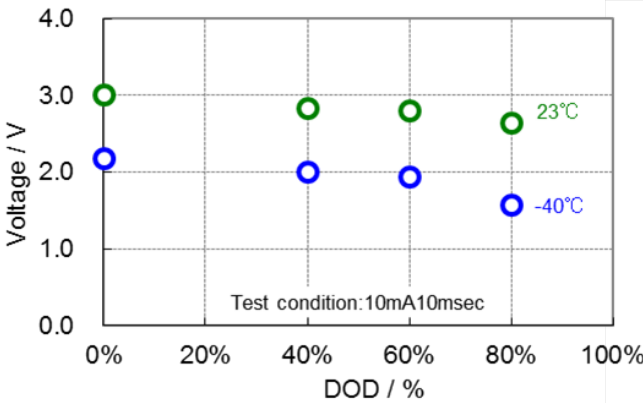

■ 内部抵抗

Impedance by Temperature

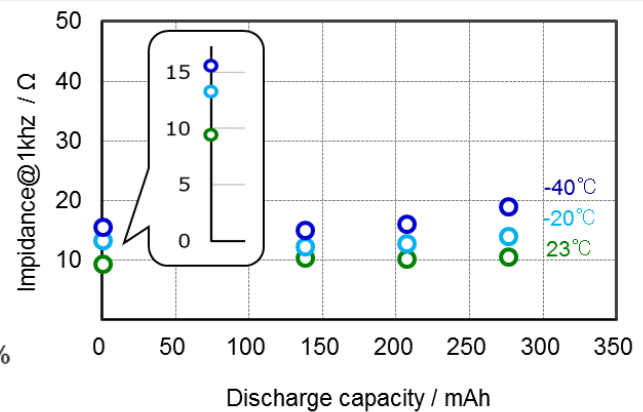

■ 自己放電特性

Self Discharge Characteristic by Temperature

注: 20°C未満の自己放電率は 20°Cと同じ自己放電率になります。  
 Note: The self-discharge rate of less than 20°C shows the same self-discharge rate as 20°C.

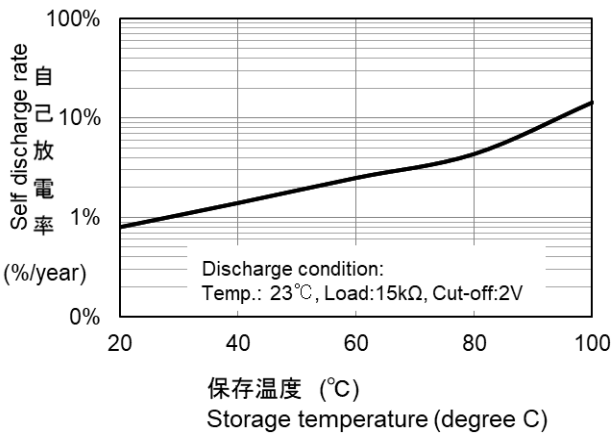

Sample

サンプル購入は下記リンクからご購入できます。  
 Purchase paid sample from the below links

Click ▶ [CR2050W](#)



Contact

? お問い合わせフォーム | [Contact Form](#)

\*記載のデータ及び数値は、参考値であり保証値ではありません。  
 \*Data is not guaranteed, and is provided for reference purposes only.